



KMY22



KMY20



KMZ20

KMY_KMZ

Linear Magnetic Field Sensors

SPECIFICATIONS

- **AMR sensor**
- **Very high sensitivity**
- **Almost no hysteresis**
- **Various applications**
- **Available with internal magnet**
- **Available in several packages**

Due to its featured properties - high sensitivity and almost no hysteresis – the **KMY / KMZ** sensors are used in a wide range of applications, like magnetic field measurement, revolution counters, proximity detecting, and position measurement.

An uniaxial linear magnetic field will generate a linear output within the specified magnetic field range.

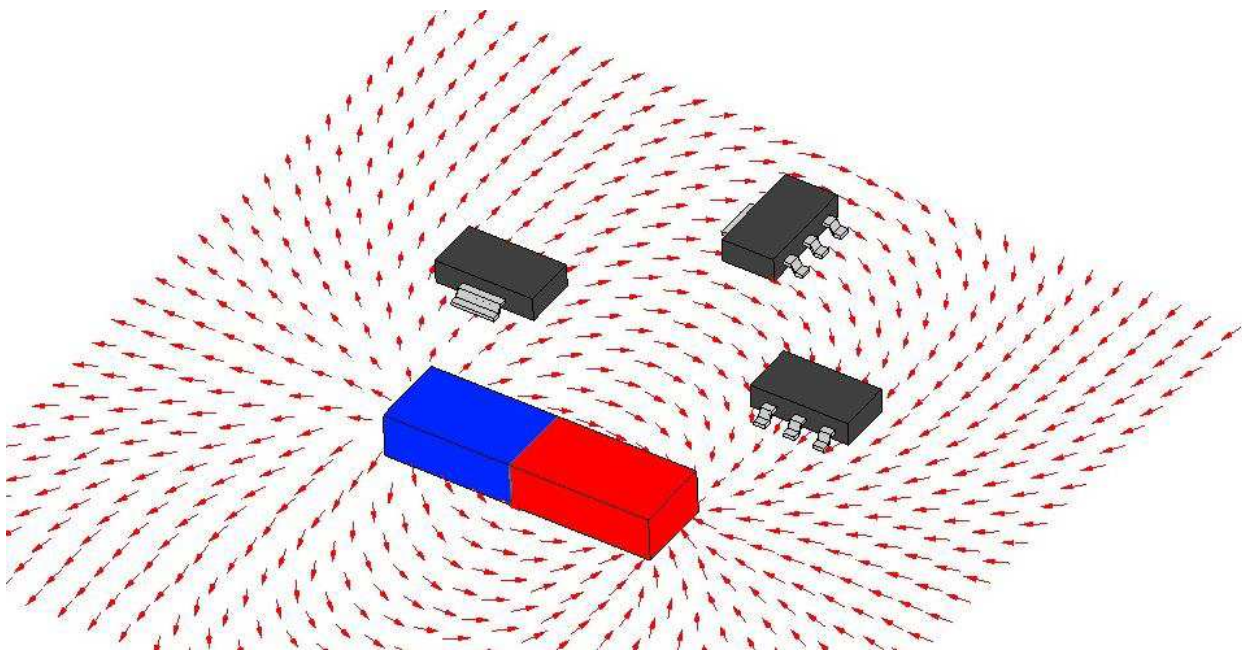

FEATURES

- Output proportional to magnetic field strength with very high sensitivity
- Very small hysteresis
- Large operating temperature range, from -40°C up to +150 °C
- Highly reliable
- With / without internal magnet

APPLICATIONS

- Detection of very weak magnetic fields, like earth magnetic field, or field generated by small magnetic particles
- Detection of objects that distort non-local magnetic fields
- Revolution measurement on ferromagnetic gears
- Contactless switch
- Contactless displacement / position sensor

DESCRIPTION

An uniaxial linear magnetic field (in y-direction) will generate a linear output within the specified magnetic field range. The sensor is available in two types: the **KMY 20 M**, **KMY 21 M** and **KMZ 20 M** sensor types contain intrinsic magnets which provide an auxiliary magnetic field (in x-direction) at the sensor die which prevents magnetic domains from flipping irregularly.

If the dies **MR174B** or the components **KMY22**, **KMY20S** or **KMZ20S** are used, the auxiliary field has to be provided by the user. The dependence of the sensitivity with auxiliary field strength is depicted in the figure aside.

Figure 1: Sensitivity dependence on auxiliary field strength

Auxiliary Field Dependence

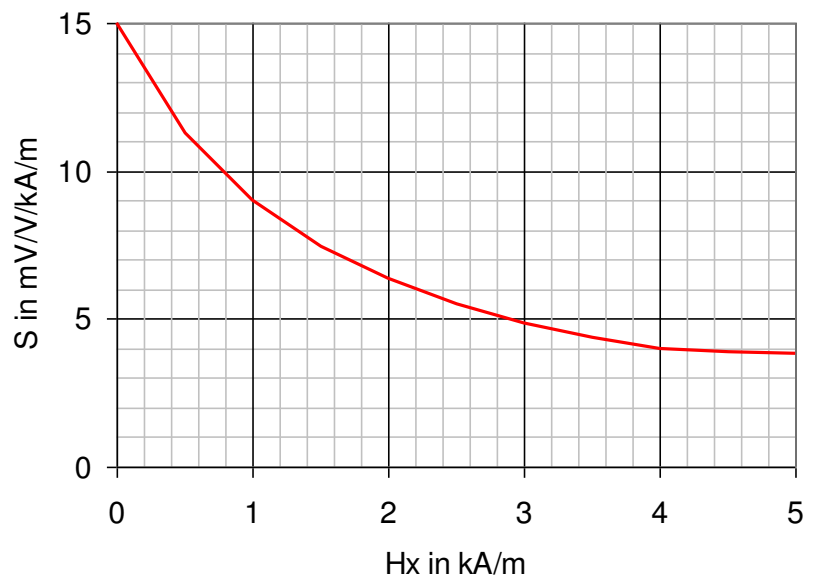

Auxiliary field strengths below $H_x < 1.5$ kA/m are not recommended, as small disturbances may flip the magnetization domains. Sometimes, the magnetic conditions in the application may provide enough H_x bias field stabilization. MEAS Germany can provide advice for customer specific magnet arrangements.

If a bias field H_x is not applied or H_x is less than 2.5 kA/m, the sensor may be used only in a limited field range H_y , depending on the present total bias field $H_{x,tot}$. In this case, it is strongly recommended to 'premagnetize' the sensor, i.e. align all magnetic domains consistently, prior to the measurement.

$H_{x,tot}$ is the sum of all acting magnetic fields in x direction at the sensor die.

Do not use the sensor outside the safe operating area. Leaving the safe operating area can destroy an existing premagnetization and therefore will lead to unreproducible sensor signals.

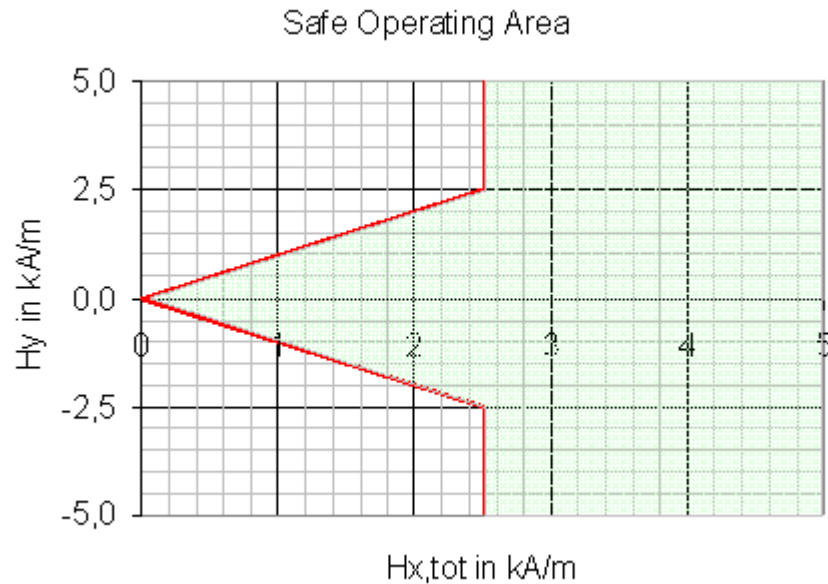

Figure 2: Safe operating area

CHARACTERISTIC VALUES / SENSOR SPECIFICATIONS

Parameter	Symbol	Condition	Min	Typ	Max	Unit
Operating Limits						
max. supply voltage	$V_{cc,max}$				10	V
max. current	$I_{cc,max}$				9	mA
operating temperature	T_{op}		-40		+150	°C
storage temperature	T_{st}		-40		+150	°C
General Sensor Specifications						
TC of amplitude	TCSV	Condition A, C		-0.35		%/K
TC of resistance	TCBR	Condition A, C		+0.35		%/K
TC of offset	TCVoff	Condition A, C	-4	0	+4	μ V/V/K
Sensor Specifications KMY 20 S, KMZ 20 S, KMY 22 (T=25 °C, Hx=3 kA/m externally)						
Supply voltage	V_{cc}	Condition A, B		5		V
Bridge resistance	R_b	Condition A, B	1200	1700	2200	Ω
Output signal range	$\Delta V_0/V_{cc}$	Condition A, B	16	20	24	mV/V
Offset voltage	V_{off}/V_{cc}	Condition A, B	-1	0	+1	mV/V
Sensitivity	S	Condition A, B	3.7	4.7	5.7	mV/V/kA/m

Hysteresis	V_H/V_{CC}	Condition A, B	-	-	50	$\mu V/V$
Sensor Specifications KMY 20 M, KMZ 20 M (T=25 °C, Hx=1.5±0.5 kA/m internally)						
Supply voltage	V_{CC}	Condition A, B		5		V
Bridge resistance	R_b	Condition A, B	1200	1700	2200	Ω
Output signal range	$\Delta V_0/V_{CC}$	Condition A, B	16	20	24	mV/V
Offset voltage	V_{off}/V_{CC}	Condition A, B	-1.5	0	+1.5	mV/V
Sensitivity	S	Condition A, B	4	5.5	7	mV/V/kA/m
Hysteresis	V_H/V_{CC}	Condition A, B	-	-	50	$\mu V/V$
Sensor Specifications KMY 21 M (T=25 °C, Hx=2.5±1.0 kA/m internally)						
Supply voltage	V_{CC}	Condition A, B		5		V
Bridge resistance	R_b	Condition A, B	1100	1500	1900	Ω
Output signal range	$\Delta V_0/V_{CC}$	Condition A, B	8	9.5	12	mV/V
Offset voltage	V_{off}/V_{CC}	Condition A, B	48	50	52	%Vcc
Sensitivity	S	Condition A, B	2.05	2.50	3.10	mV/V/kA/m
Hysteresis	V_H/V_{CC}	Condition A, B	-	-	50	$\mu V/V$

Stress above one or more of the limiting values may cause permanent damage to the device. Exposure to limiting values for extended periods may affect device reliability.

MEASUREMENT CONDITIONS

Parameter	Symbol	Unit	Condition
Condition A: Set Up Conditions			
Ambient temperature	T	°C	23±5 Measurement results are extrapolated to 25°C by using the given temperature coefficients
Supply voltage	V_{CC}	V	5
Output voltage	V_O V_O/V_{CC}	mV mV/V	$V_O=(V_{0+} - V_{0-})$ Output voltages are also given independently on supply voltage: example: $V_O/V_{CC}=(V_{0+} - V_{0-})/V_{CC}$; measure MR half bridge against reference half bridge
Reference half bridge			2* 2 k Ω 0.1% (KMY21M only)
for full bridge sensors (KMY20S, KMY20M, KMY22, KMZ20S, KMZ20M)		for half bridge sensors (KMY 21 M)	



		The output voltage of the MR half bridge is measured against a reference half bridge	
Condition B: Sensor Specifications (T=25 °C, S-Type: Hx=3.0±0.5 kA/m)			
Output voltage range	$\Delta V_o/V_{cc}$	mV/V	$H_y = -7 \dots +7 \text{ kA/m}; \Delta V_o = (V_{o,max} - V_{o,min})$
Offset voltage	V_{off}/V_{cc}	mV/V	$H_y = 0; V_{off} = V_o(H_y)$
Sensitivity	S	(mV/V)/(kA/m)	$H_y = 1 \text{ kA/m}; S := \frac{V_o(+H_y) - V_o(-H_y)}{2 \cdot V_{cc}}$
Hysteresis	V_H/V_{cc}	$\mu\text{V/V}$	H_y in kA/m $(V_o(H_y = 0; H_y = -1 \rightarrow +1) - V_o(H_y = 0; H_y = +1 \rightarrow -1))/V_{cc}$
Condition C: Sensor Specifications (reference temperatures T=-25°C, +125°C)			
Ambient temperatures	T	°C	$T_1 = -25 \text{ °C}, T_0 = +25 \text{ °C}, T_2 = +125 \text{ °C}$
TC of amplitude	TCSV	%/K	$TCV = \frac{1}{(T_2 - T_1)} \cdot \frac{\Delta V_o/V_{cc}(T_2) - \Delta V_o/V_{cc}(T_1)}{\Delta V_o/V_{cc}(T_1)} \cdot 100\%$
TC of resistance	TCBR	%/K	$TCR = \frac{1}{(T_2 - T_1)} \cdot \frac{R(T_2) - R(T_1)}{R(T_1)} \cdot 100\%$
TC of offset	TCVoff	($\mu\text{V/V}$)/K	$TCV_{off} = \frac{V_{off}(T_2) - V_{off}(T_1)}{(T_2 - T_1)}$

SENSOR MODELS

KMY 20 / KMY 22 / KMZ 20

The KMY and KMZ sensors are highly sensitive magnetic field sensors which utilize the anisotropic magneto resistance effect. The KMY 20 and KMZ 20 sensors contain a Wheatstone bridge.

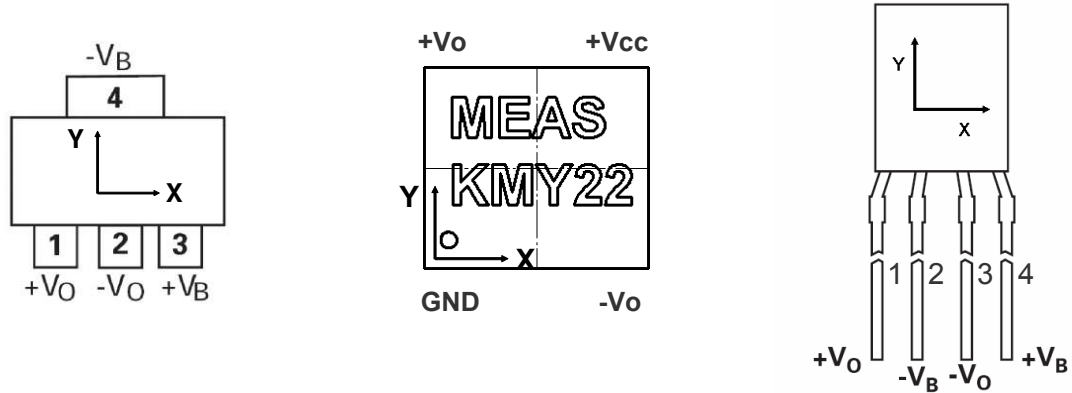

Figure 3: Pad annotation and definition of field direction for KMY & KMZ

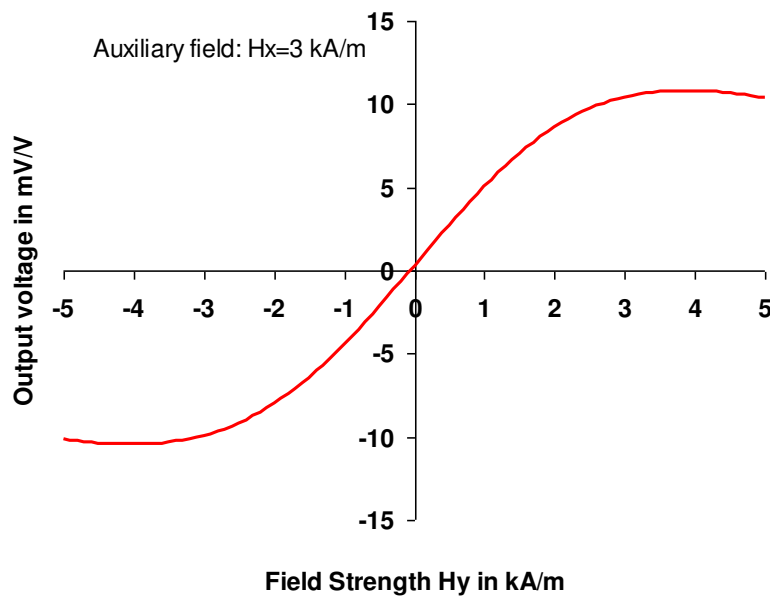
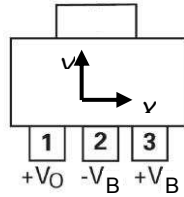

Figure 4: Characteristic output curve of KMY 20 S / KMY 22 / KMZ 20 S for an auxiliary field strength of $H_x=3$ kA/m

KMY 21

In contrast to the KMY20 sensor products, the **KMY 21 M** consists of a half bridge, making the sensor well suited for dynamic measurements.



It contains an internal magnet, which provides an auxiliary field of approx. 2.5 kA/m.

Figure 5: Characteristic curve for KMY21M

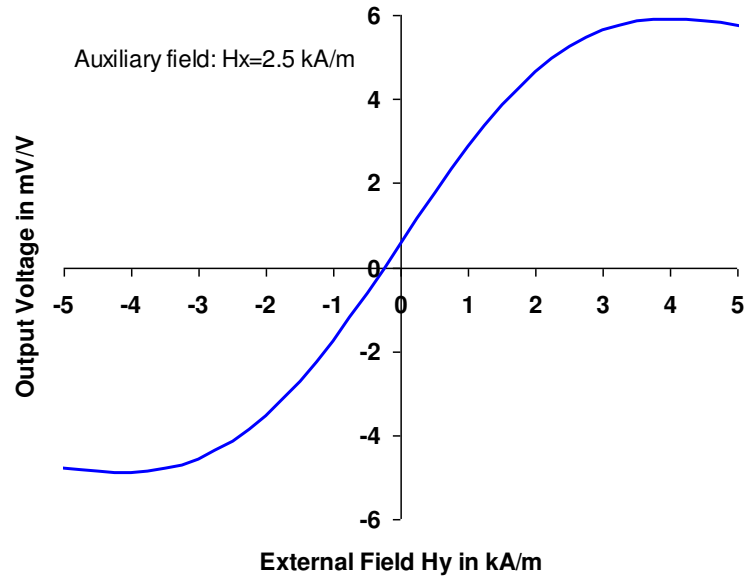

TEMPERATURE DEPENDENCIES

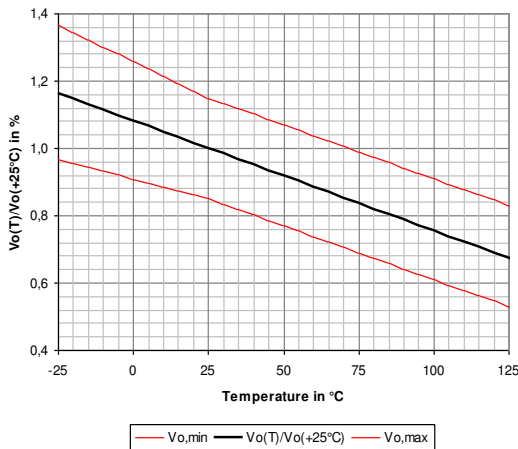

Figure 6: signal amplitude related to room temperature value

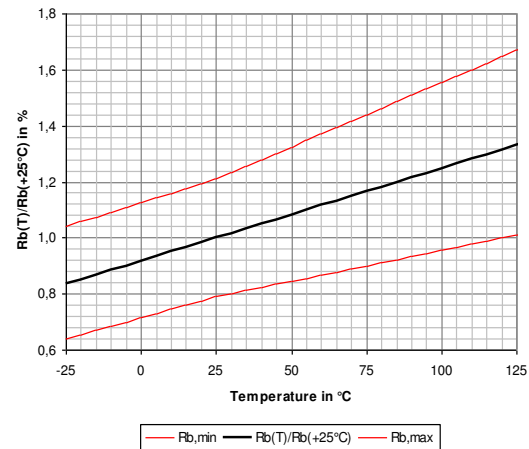
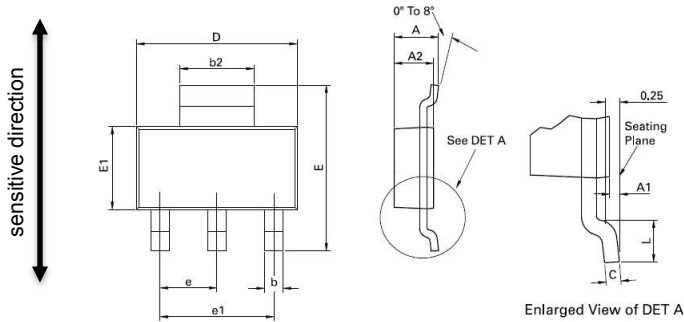

Figure 7: bridge resistance related to room temperature value

PACKAGES

SOT223

Recommended solder reflow process for all packages according to IPC/JEDEC J-STD-020D (Pb-Free Process)



DIM	Millimeters		Inches		DIM	Millimeters		Inches	
	Min	Max	Min	Max		Min	Max	Min	Max
A	-	1.80	-	0.071	e	2.30 BSC		0.0905 BSC	
A1	0.02	0.10	0.0008	0.004	e1	4.60 BSC		0.181 BSC	
b	0.66	0.84	0.026	0.033	E	6.70	7.30	0.264	0.287
b2	2.90	3.10	0.114	0.122	E1	3.30	3.70	0.130	0.146
C	0.23	0.33	0.009	0.013	L	0.90	-	0.355	-
D	6.30	6.70	0.248	0.264	-	-	-	-	-

Note: Controlling dimensions are in millimeters. Approximate dimensions are provided in inches

E-LINE 4 PIN

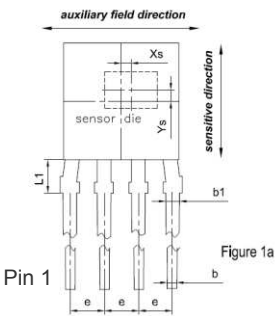
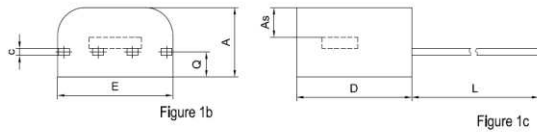

DIE POS.	Millimeter			Inches		
	KMZ20S	KMZ20M	tolerances	KMZ20S	KMZ20M	tolerances
Xs	+0.05	+0.05	+/-0.10	+0.002	+0.002	+/-0.004
Ys	+0.50	+0.50	+/-0.10	+0.02	+0.02	+/-0.004
As	1.05	1.05	+/-0.10	0.041	0.041	+/-0.004

DIM	Millimeter			Inches		
	min.	typ.	max.	min.	typ.	max.
A	2.4		2.8	0.094		0.110
b	0.35		0.48	0.0138		0.0189
b1	0.45		0.60	0.0178		0.024
c	0.25		0.35	0.0098		0.0138
D	4.0		4.4	0.157		0.173
E	3.8		4.4	0.150		0.173
L	12.0		14.0	0.472		0.551
e	NOM. 1.25			NOM. 0.049		
L1	1.1		1.3	0.043		0.051

UTDFN8 2.5X2.8 MM

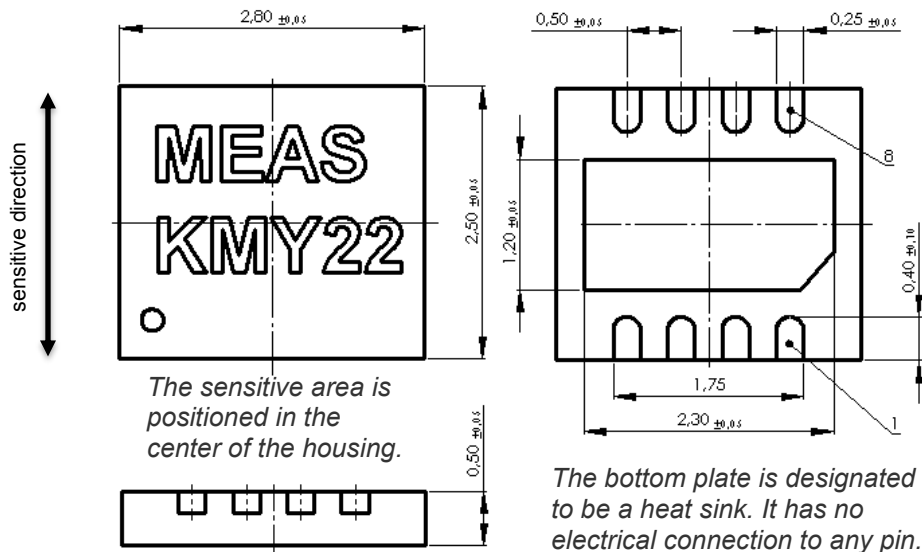



ORDERING CODE

DEVICE	DIE	PACKAGE	INTERNAL MAGNET	PART NUMBER
KMY20 S	full bridge	SOT-223	NO	G-MRCO-006
KMY20 M	full bridge	SOT-223	YES	G-MRCO-001
KMY21 M	half bridge	SOT-223	YES	G-MRCO-011
KMZ20 S	full bridge	E-Line	NO	G-MRCO-007
KMZ20 M	full bridge	E-Line	YES	G-MRCO-003
KMY22	full bridge	UTDFN8	NO	<i>on request</i>

ORDERING INFORMATION